



**HOSHIZAKI**

**> KMD-270AA**

daily ice production capacity of up to 270kg



Crescent-shaped ice moves around freely yet packs together tightly in its bin, maximising storage capacity. Individual crescents do not stick together as there are no air pockets so that each piece of ice comes across distinctive in a cup of drink. This unit can be fitted on a dispenser for quick and ease-of- access.



**> KMD-270AA**  
(With Hoshizaki Storage Bin - **B-301SA**)

CRESCENT ICE MAKER SERIES

**FEATURES**

- > stainless steel evaporator
- > audible controller board
- > easy cleaning with pull out filter & removable water tank
- > low 53db noise level
- > fitted with reliable mechanical proximity bin control switch
- > cyclesaver® design 
- > evercheck® alert 
- > compartmentalised internal design
- > able to be installed on 560mm (22") wide drink dispenser
- > water cooled model available

**ICE SIZE**

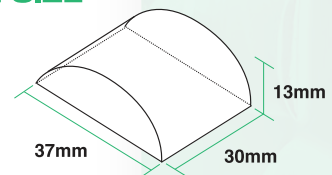

**Crescent Ice Maker  
KMD-270AA**

**Allows installation  
on 560mm(22")wide  
drink dispenser.**





**HOSHIZAKI**

## > **KMD-270AA**

daily ice production capacity of up to 265kg



Crescent-shaped ice moves around freely yet packs together tightly in its bin, maximising storage capacity. Individual crescents do not stick together as there are no air pockets so that each piece of ice comes across distinctive in a cup of drink. This unit can be fitted on a dispenser for quick and ease-of- access.



> **KMD-270AA**  
(With Hoshizaki Storage Bin - **B-301SA**)

CRESCENT ICE MAKER SERIES

### FEATURES

- > stainless steel evaporator
- > audible controller board
- > easy cleaning with pull out filter & removable water tank
- > low 53db noise level
- > fitted with reliable mechanical proximity bin control switch
- > cyclesaver® design 
- > evercheck® alert 
- > compartmentalised internal design
- > able to be installed on 560mm (22") wide drink dispenser
- > water cooled model available

### ICE SIZE

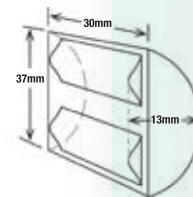

#### Crescent Ice Maker **KMD-270AA**

Allows installation  
on 560mm(22")wide  
drink dispenser.





**HOSHIZAKI**

## > **KM-901MAH50**

daily ice production capacity of up to 400kg



> **KM-901MAH50**  
(With Hoshizaki Storage Bin - **B-900**)

Crescent-shaped ice moves around freely yet packs together tightly in its bin, maximising storage capacity. Individual crescents do not stick together as there are no air pockets so that each piece of ice comes across distinctive in a cup of drink. This unit meets the need for large amounts of ice daily.

CRESCENT ICE MAKER SERIES

### FEATURES

- > stainless steel exterior and evaporator
- > cyclesaver<sup>®</sup> design 
- > evercheck<sup>®</sup> alert 
- > removable and cleanable air filters
- >  hoshiguard antimicrobial agent

### AVAILABLE MODELS

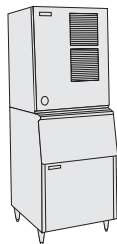

**KM-901MAH50**  
+  
**BIN - B501SA**

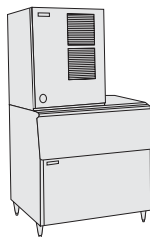

**KM-901MAH50**  
+  
**BIN - B801SA**

### ICE SIZE

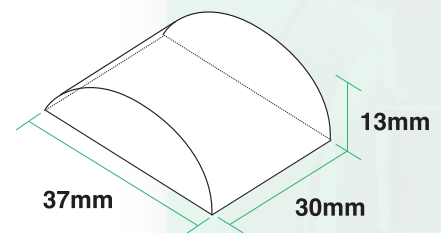



**HOSHIZAKI**

CRESCENT ICE MAKER SERIES

> **KM-1301SAH-E**



daily ice production capacity of up to 505kg



> **KM-1301SAH-E**  
(With Hoshizaki Storage Bin - **B-900**)

Crescent-shaped ice moves around freely yet packs together tightly in its bin, maximising storage capacity. Individual crescents do not stick together as there are no air pockets so that each piece of ice comes across distinctive in a cup of drink. This unit meets the need for large amounts of ice daily and is stackable without taking up any added floor space.

**FEATURES**

- > stainless steel exterior and evaporator
- > cyclesaver® design 
- > evercheck® alert 
- > removable and cleanable air filters
- >  hoshiguard antimicrobial agent
- > stackable to provide up to 1010kg daily production capacity

**AVAILABLE MODELS**



**KM-1301SAH-E**  
+  
**BIN - B-800**

**ICE SIZE**

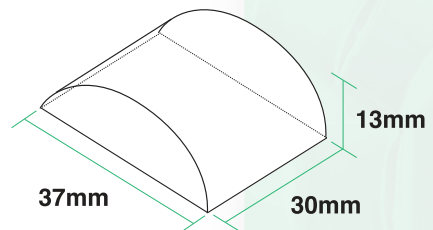



**HOSHIZAKI**

- > **IM-240ANE**
- > **IM-240ANE-21**
- > **IM-240ANE-23**

daily ice production capacity of up to 240kg



Cube ice is perfectly symmetrical and leaves a good impression with its hard, crystal clear quality that melts very slowly; allowing customers to enjoy their favourite drink longer. The IM series allows more flexibility of application with each range offering ice in variable sizes alongside a design for uncomplicated usage from start to finish.



> **IM-240ANE**  
(With Hoshizaki Storage Bin - **B-301SA**)

CUBE ICE MAKER SERIES

## FEATURES

- > smart computer board technology
- > slide-in air filter for easy cleaning
- > stainless steel exterior



## UNIQUE ICE PRODUCTION SYSTEM FOR ICE CUBE

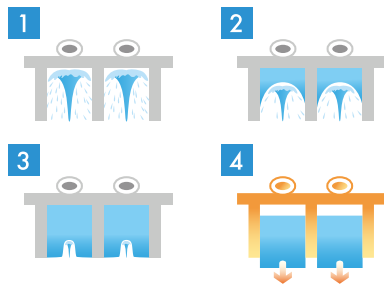

## ICE SIZE

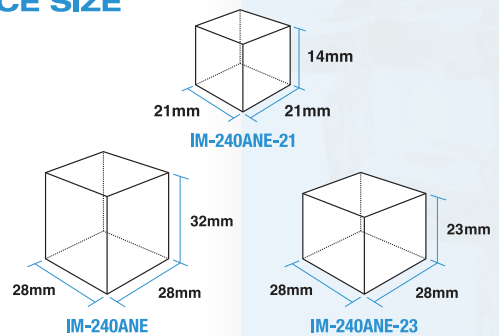



**HOSHIZAKI**

> **IM-45NE**  
> **IM-45NE-25**

daily ice production capacity of up to 44kg



Cube ice is perfectly symmetrical and leaves a good impression with its hard, crystal clear quality that melts very slowly; allowing customers to enjoy their favourite drink longer. The IM series allows more flexibility of application with each range offering ice in variable sizes alongside a design for uncomplicated usage from start to finish.



> **IM-45NE**

CUBE ICE MAKER SERIES

**FEATURES**

- > smart computer board technology
- > slide-in air filter for easy cleaning
- > LED error indicator for easy diagnosis
- > stainless steel exterior



**UNIQUE ICE PRODUCTION SYSTEM**

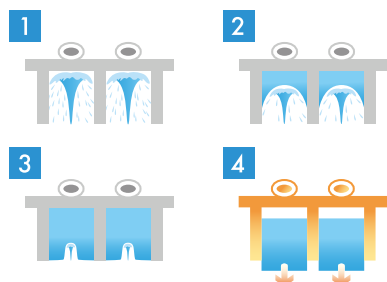

**ICE SIZE**

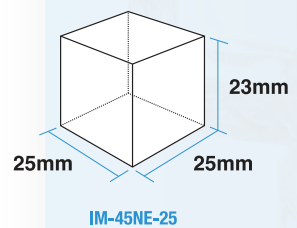
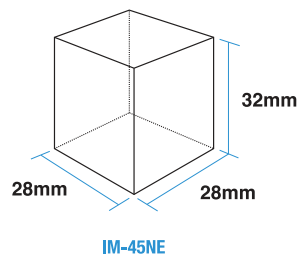



**HOSHIZAKI**

> **IM-65NE**  
> **IM-65NE-25**

daily ice production capacity of up to 63kg



Cube ice is perfectly symmetrical and leaves a good impression with its hard, crystal clear quality that melts very slowly; allowing customers to enjoy their favourite drink longer. The IM series allows more flexibility of application with each range offering ice in variable sizes alongside a design for uncomplicated usage from start to finish.



> **IM-65NE**

CUBE ICE MAKER SERIES

**FEATURES**

- > smart computer board technology
- > slide-in air filter for easy cleaning
- > LED error indicator for easy diagnosis
- > stainless steel exterior

**UNIQUE ICE PRODUCTION SYSTEM FOR ICE CUBE**

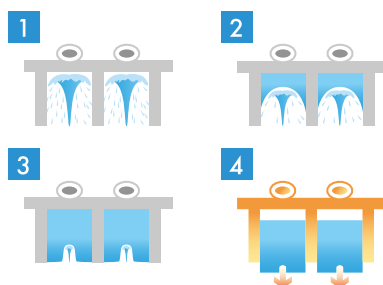

**ICE TYPE & SIZE**

**CUBE**

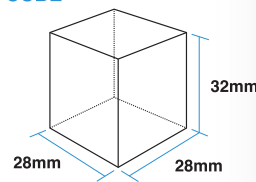

**IM-65NE**

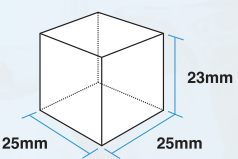

**IM-65NE-25**

**UPON REQUEST:**

**BALL**



Golf ball ice model available.  
(Model - **IM-65LE-Q**).

**CYLINDER**

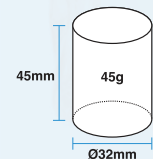

Cylinder ice model available.  
(Model - **IM-65LE-Q**).





**HOSHIZAKI**

CUBE ICE MAKER SERIES

> **IM-65A**

daily ice production capacity of up to 70kg



Cube ice is perfectly symmetrical and leaves a good impression with its hard, crystal clear quality that melts very slowly; allowing customers to enjoy their favourite drink longer. The I-Fit series of cube ice maker produces standard size ice (28x28x32mm) that is applicable in many settings and designed for uncomplicated usage from start to finish.



> IM-65A

**I-FIT**  
SERIES

**FEATURES**

- > flush-back design for easy installation
- > round front door for quick access to ice
- > one-piece door design and pull-out air filter for simple cleaning
- > front water valve access for easy serviceability
- > sharp stainless steel exterior



**UNIQUE ICE PRODUCTION SYSTEM**

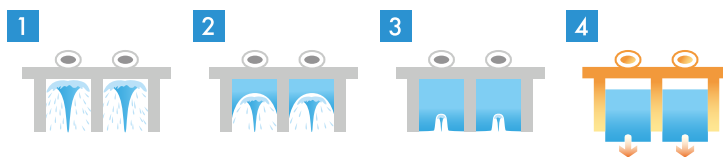

**ICE SIZE**

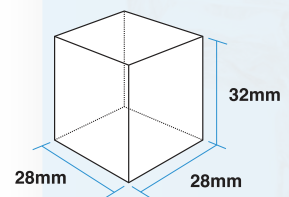





**HOSHIZAKI**

## > **IM-100A**

daily ice production capacity of up to 112kg



Cube ice is perfectly symmetrical and leaves a good impression with its hard, crystal clear quality that melts very slowly; allowing customers to enjoy their favourite drink longer. The I-Fit series of cube ice maker produces standard size ice (28x28x32mm) that is applicable in many settings and designed for uncomplicated usage from start to finish.



> IM-100A

CUBE ICE MAKER SERIES

**I-FIT**  
SERIES

### **FEATURES**

- > flush-back design for easy installation
- > round front door for quick access to ice
- > one-piece door design and pull-out air filter for simple cleaning
- > front water valve access for easy serviceability
- > sharp stainless steel exterior



### **UNIQUE ICE PRODUCTION SYSTEM**

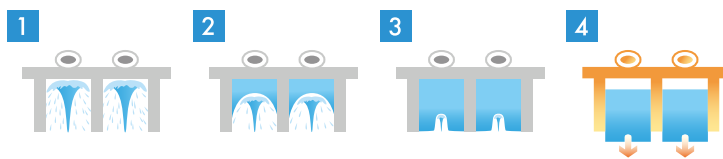

### **ICE SIZE**

